

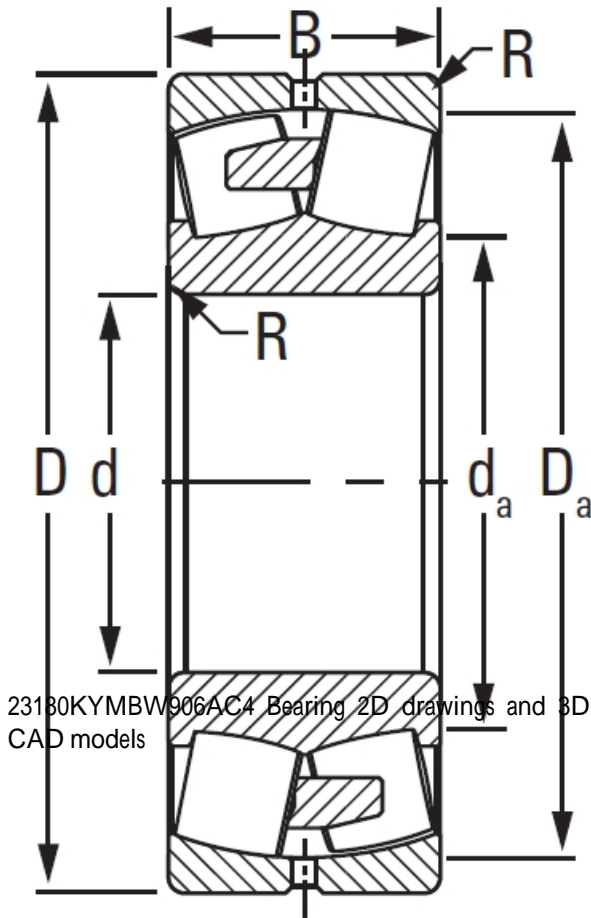

23180KYMBW906AC4 TIMKEN Tapered Roller Bearings

Bearing No. 23180KYMBW906AC4



23180KYMBW906AC4 Bearing 2D drawings and 3D CAD models

Design Unit	METRIC
Bore Taper	1/12
Bearing Weight	261.60 Kg
Cage Type	YMB
Cage Material	Brass
d	400.000 mm
D	650.000 mm
B - Inner Ring Width	200 mm
B - Outer Ring Width	200.000 mm
R - Inner Ring To Clear Radius ¹	5.000 mm
r - Outer Ring To Clear Radius ²	5.000 mm
da - Inner Ring Backing Diameter	454.000 mm
Da - Outer Ring Backing Diameter	594.000 mm
C0 - Static Radial Rating	8110000 N
C1(2) - Dynamic Radial Rating (Two-Rows)	4770000 N
e - ISO Factor ³	0.29
Y0 - ISO Factor ⁴	2.32
Y1 - ISO Factor ⁵	3.46
Y2 - ISO Factor ⁶	2.27
Reference Thermal Speed Rating (Grease)	480
Reference Thermal Speed Rating (Oil) ⁷	530



Xili Bearing Co., Ltd

Cg - Geometry Factor ⁸	0.0922
-----------------------------------	--------